

HORIZONTAL MACHINING CENTER

High speed High precision High efficiency

DH-63
DH-100S

Taikan

HIGH-END INTELLIGENT EQUIPMENT TURNKEY SOLUTION SERVICE PROVIDER



SHENZHEN CREATE CENTURY AUTOMATION TECHNOLOGY CO., LTD.

Address: Room 201 Building 2, No.180 Huangpu East Ring Road, Huangpu Community, Xingjiao Street,
Bao'an District, Shenzhen, China

Tel.: +86(755)2996-5778

E-mai: overseas-marketing@szccm.com

Website: www.taikanmachine.com

HIGH-END INTELLIGENT EQUIPMENT TURNKEY SOLUTION SERVICE PROVIDER

DH-63

Double pallets switching/horizontal machining center--DH series

- ★ High-precision cam rotary table
- ★ High speed and high rigidity motorized spindle
- ★ Large capacity tool magazine

DH-63

Spindle speed: 80~10000r/min
Worktable size: 2×630mm×630mm
Maximum worktableload: 1200kg
Maximum workpiece size: Φ1000×1000



High speed
High precision
High efficiency



Workpiece display



Double pallets switching/horizontal machining center--DH series

Equipment structure technical description

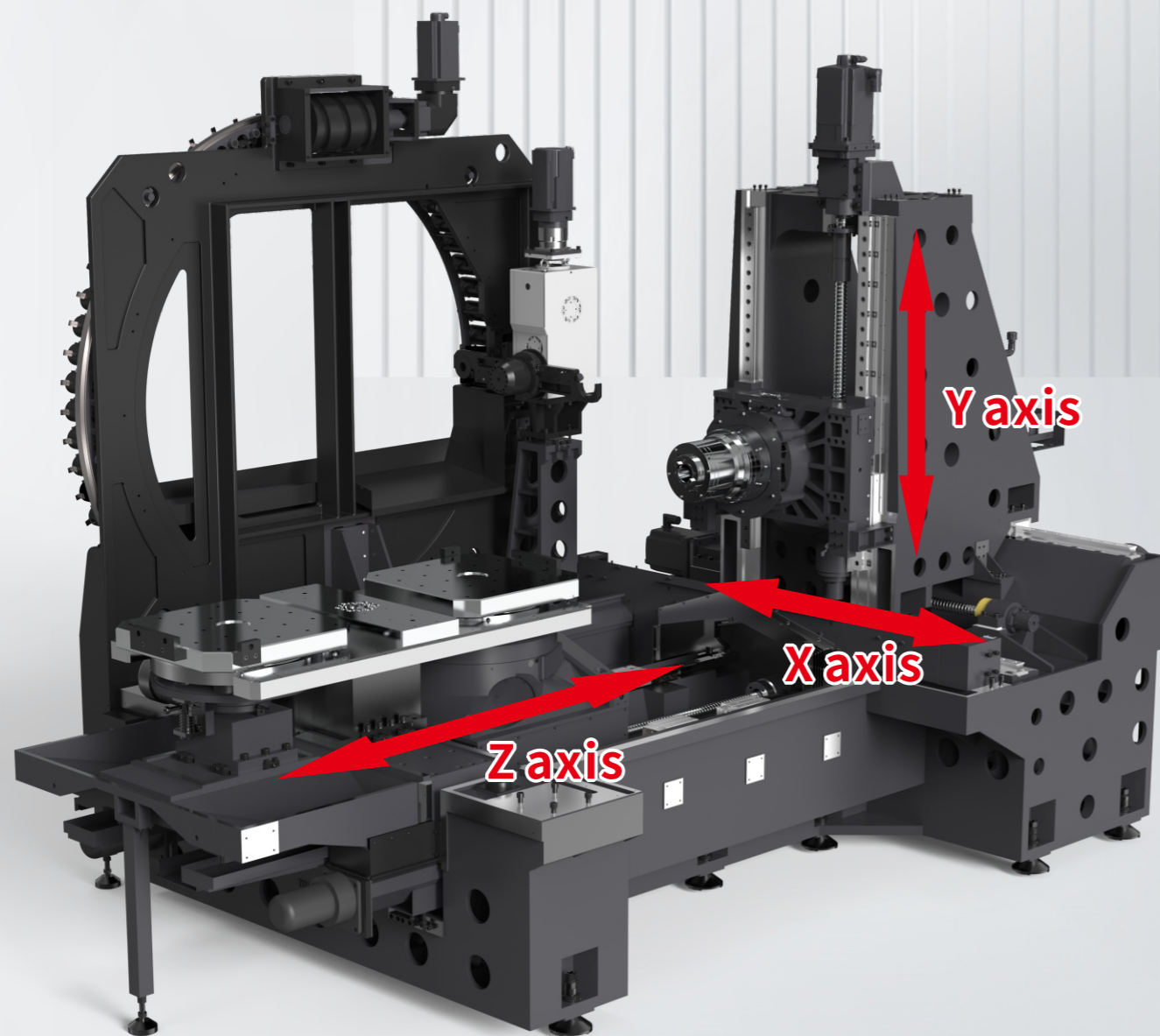

Double pallets switching/horizontal machining center--DH series

Newly optimised structural design and steadily upgraded machining performance

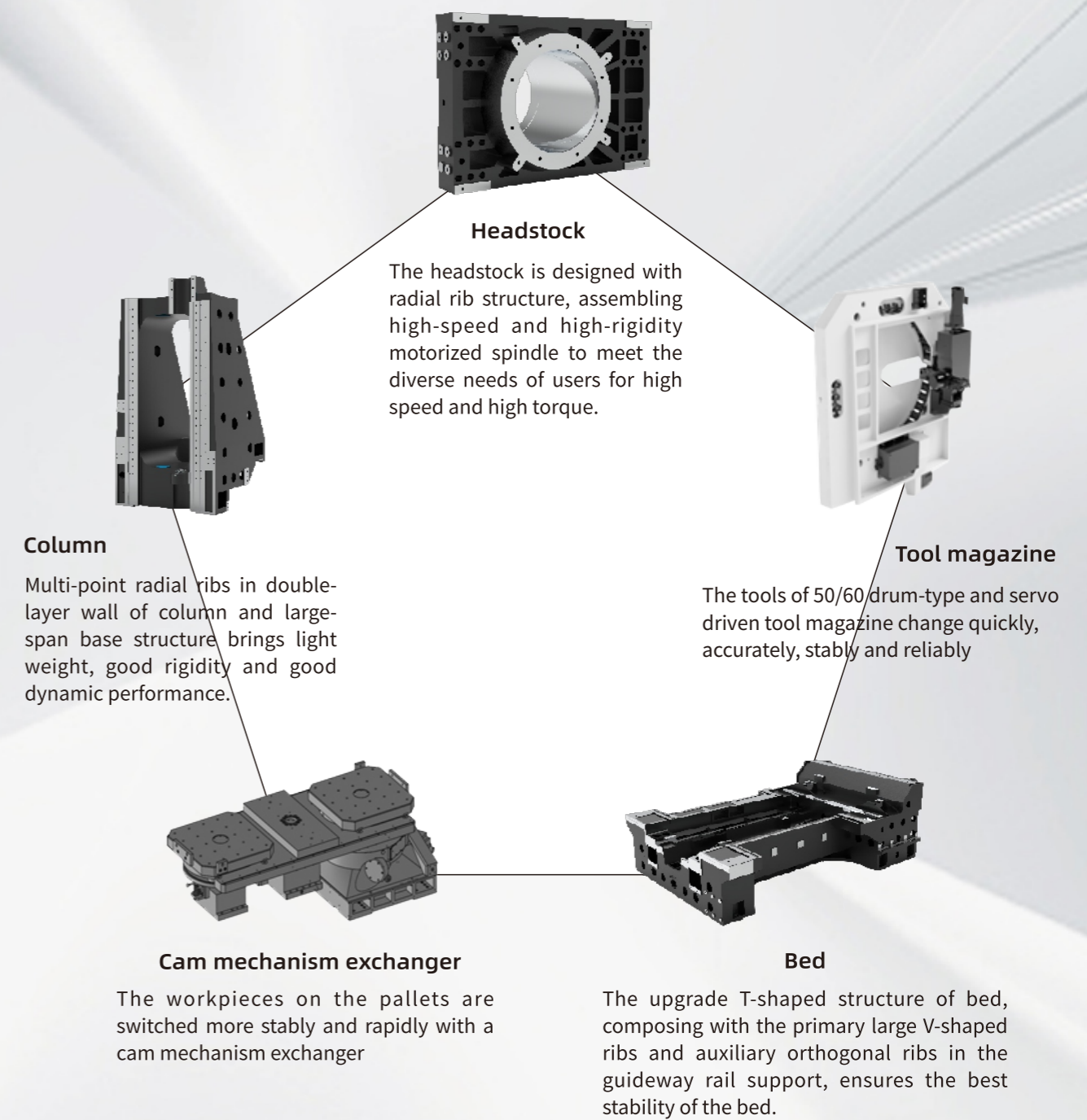

Features & Technology

Structure & Configuration

Options & Highlights

Parameters & sizes

DH-100S

Single worktable/horizontal machining center--DHS series

DH-100S

Spindle speed: 80~10000r/min

Worktable size: 1000mm×1250mm

Maximum worktableload: 5000kg

Maximum workpiece size: $\Phi 2000 \times 1800$

Single rotation worktable in large space expands its processing capabilities

- Equipped with chain-type floor-standing tool magazine
- The big parts of base are made of high-strength cast iron by high-quality resin sand molding so as to obtain high rigidity and stable accuracy
- The main castings have been subjected to finite element analysis to optimize the rib layout to fully meet the needs of the machine tool for high-torque cutting.

High speed
High precision
High efficiency

Single worktable/horizontal machining center--DHS series

Multi-process machining on sides



Single worktable/horizontal machining center--DHS series

**Stably accuracy promotion
 coolant through hollow ball screws**

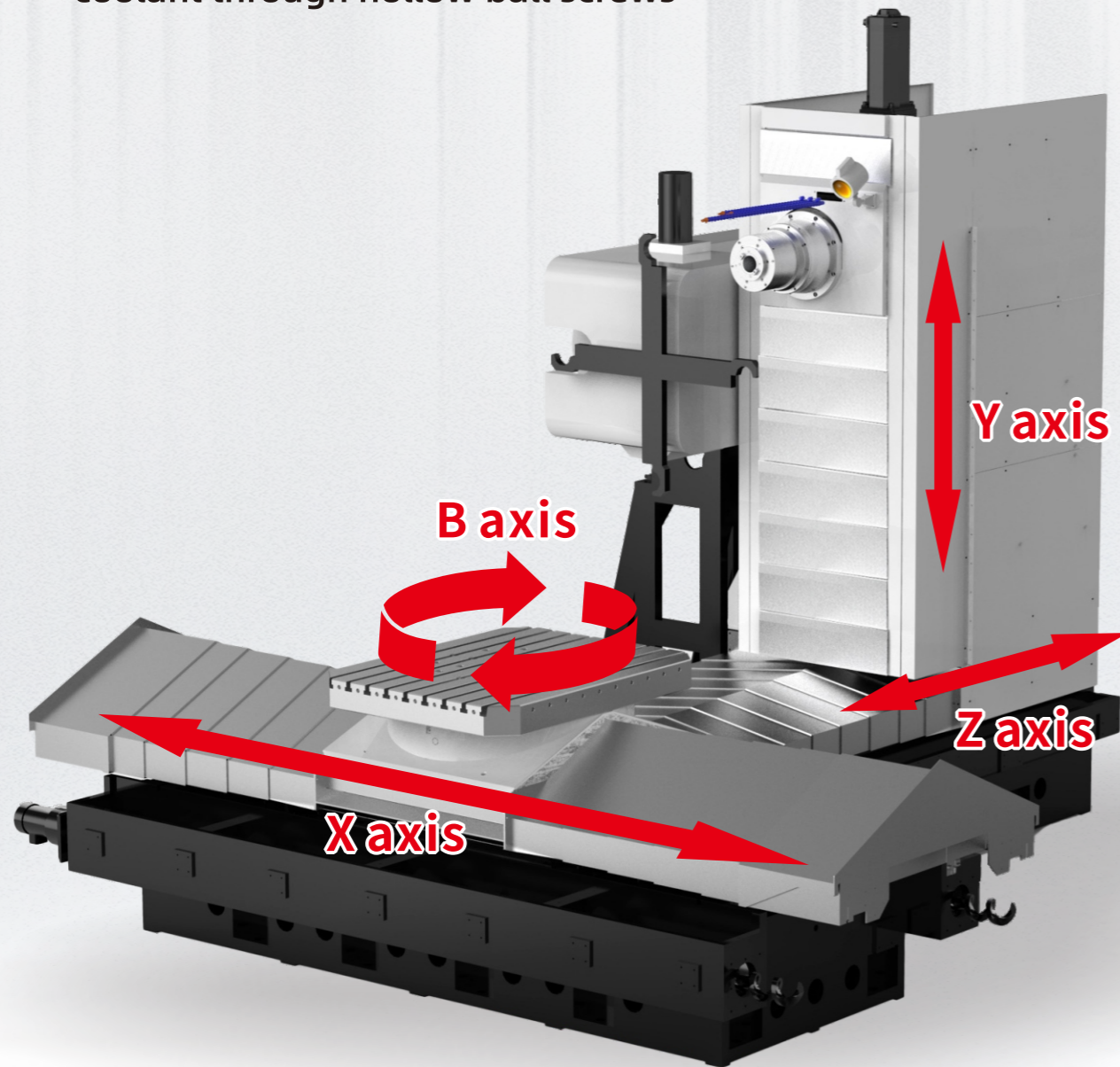

Single worktable/horizontal machining center--DHS series

**High-rigidity mechanical structure layout to
 enhance the machine's cutting ability**

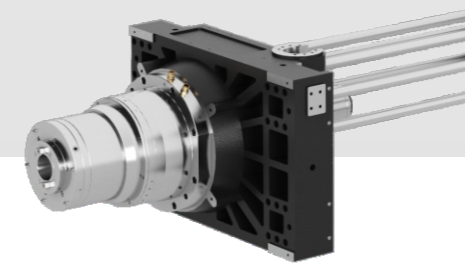

Headstock

The radial rib structure of the headstock, assembling with long-nose, high-speed and high rigidity motorized spindle, can meet the diverse needs of users for high speed and large torque.

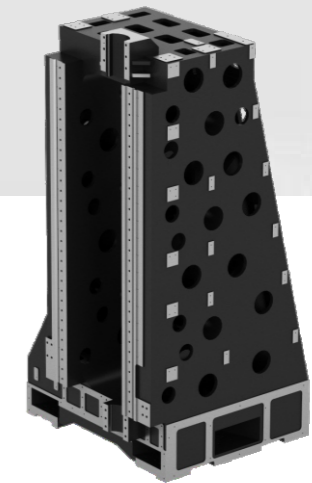

Column

High-rigidity straddle structure with multi radial ribs layout.



High precision cam rotary table

High-precision rotary table with cam and roller transmission, large-span heavy-duty design.



Bed

High-quality cast iron material, inverted T-shaped casting bed structure layout.

Stable moving mechanical parts Switching APC mechanism and high-precision rotary table

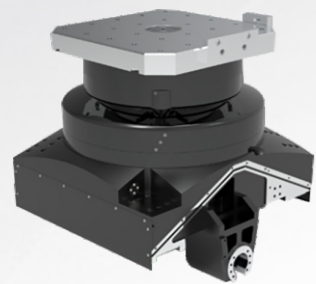

High-precision direct drive rotary table DD motor optional

It is equipped with a high-torque frameless direct-drive motor and has a compact structural design. The rotor of motor and the rotation mechanism of rotary table are integrated, providing excellent transmission rigidity.

It equipped with special bearings for large-diameter high-precision rotary tables and a centripetal thrust combination structure, it can withstand bidirectional axial load, radial load and overturning torque, and has the characteristics of high rigidity and high precision.

It is equipped with Renishaw circular grating for position feedback to ensure the best rotation positioning accuracy of the rotary table.

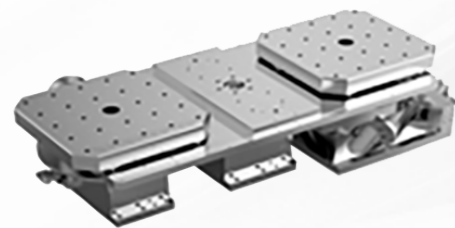

Cam mechanism of APC

The cam mechanism of APC adopts the lifting and rotating technology by mechanical cam structure, which integrates lifting, rotating exchange, and lowering actions, All sequential actions are realized through the cam box.

It has the performance of fast switching speed, strong load capacity and accurate positioning.



High precision cam rotary table

It is positioned by high-precision taper pins with hydraulic double-force locking mechanism to ensure the clamping and stability of worktable without vibration during the cutting process.

The cam-type CNC rotary table is driven by the curved surface of the cam and the contact transmission of preloaded rollers turning in the bearing of rotary station under constant speed. It has the operation characteristics of high precision, high speed, zero backlash and heavy load.

Powerful cutting capability is guaranteed High-torque and high-rigidity motorized spindle system

- ★ Integrate high-power motor
- ★ High rigidity and high precision spindle
- ★ Two windings lift automatically
- ★ Max. speed 10000r/min, Max. torque 630N.m

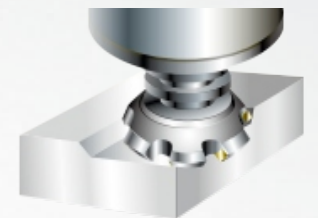
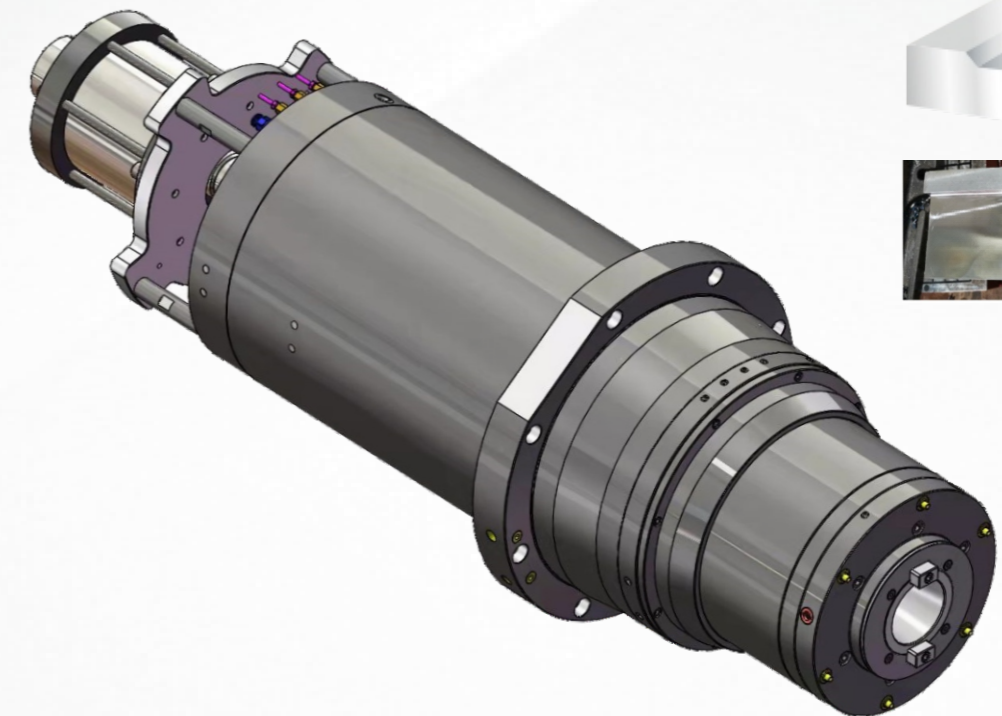

Heavy-duty cutting test of BT50 10000 RPM spindle

Tool diameter	Processing material	Processing speed r/min	Feedrate mm/min	Cutting depth (mm)	Cutting width (mm)	Line speed mm/min	Spindle load	B-axis load
D100	45#steel	500	400	8	80	157	62%	11%
D100	45#steel	500	400	10	80	157	75%	12%

Spindle copes with various working conditions

Suitable for Siemens BT50-10000rpm motorized spindle
 (Standard configuration of DH-63/DH-100S)

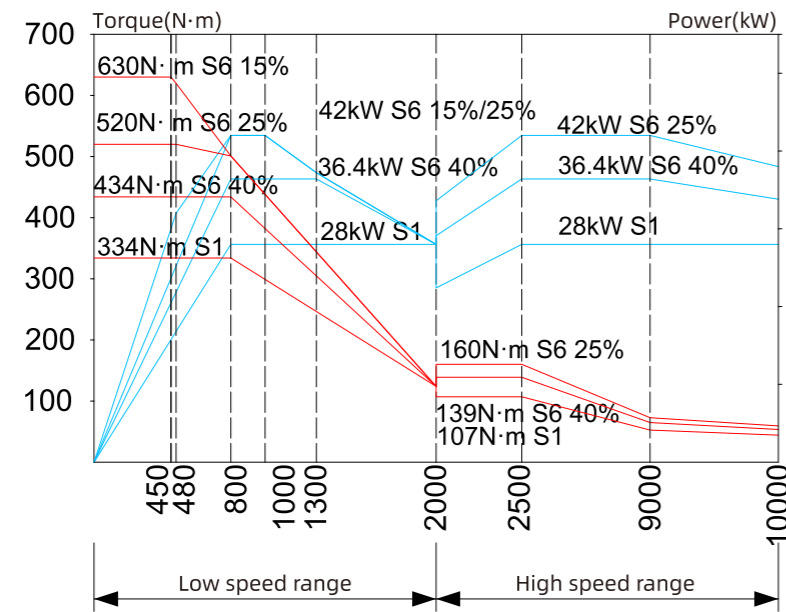

Spindle copes with various working conditions

Suitable for FANUC BT50-10000rpm motorized spindle
 (DH-63/DH-100S optional)

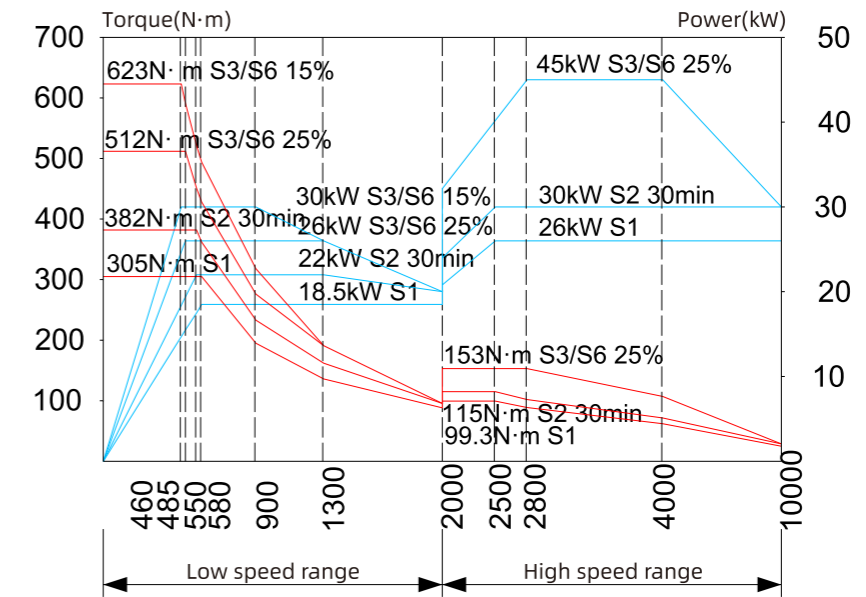

Suitable for FANUC BT50-8000rpm motorized spindle
 (DH-63/DH-100S optional)

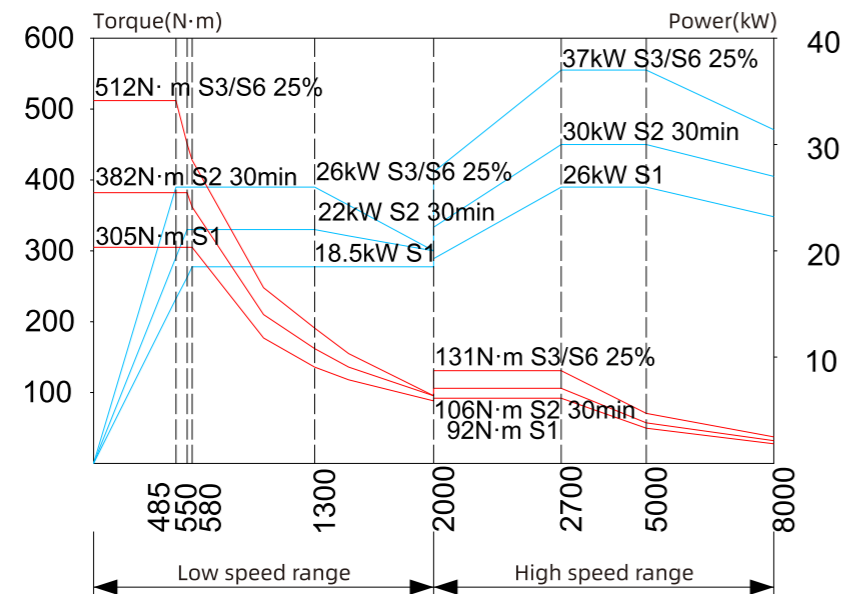

Suitable for FANUC BT50-10000rpm high-torque Motorized spindle
 (DH-63/DH-100S optional)

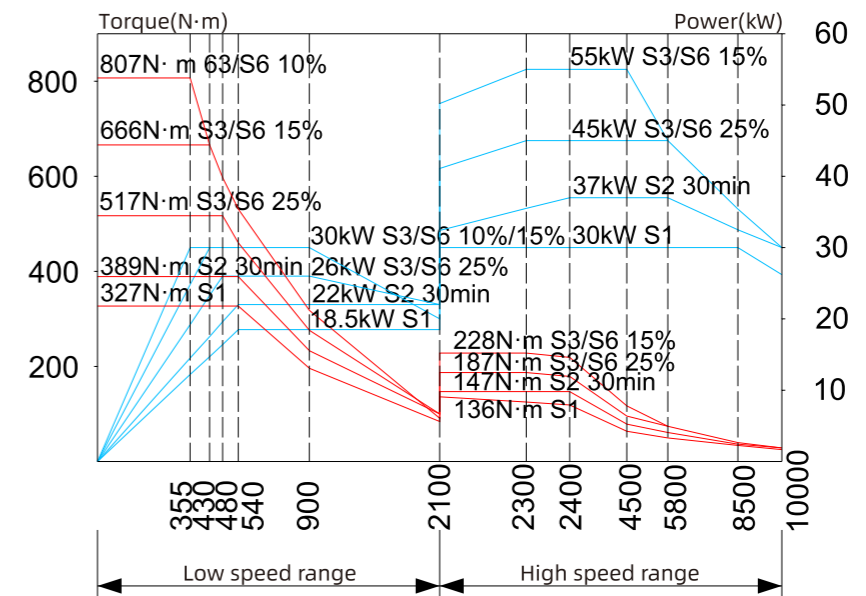

Improvement of accuracy stability—Coolant through hollow ball screws

Under water cooling, the smaller ball screw expands, the more stable accuracy it obtains.

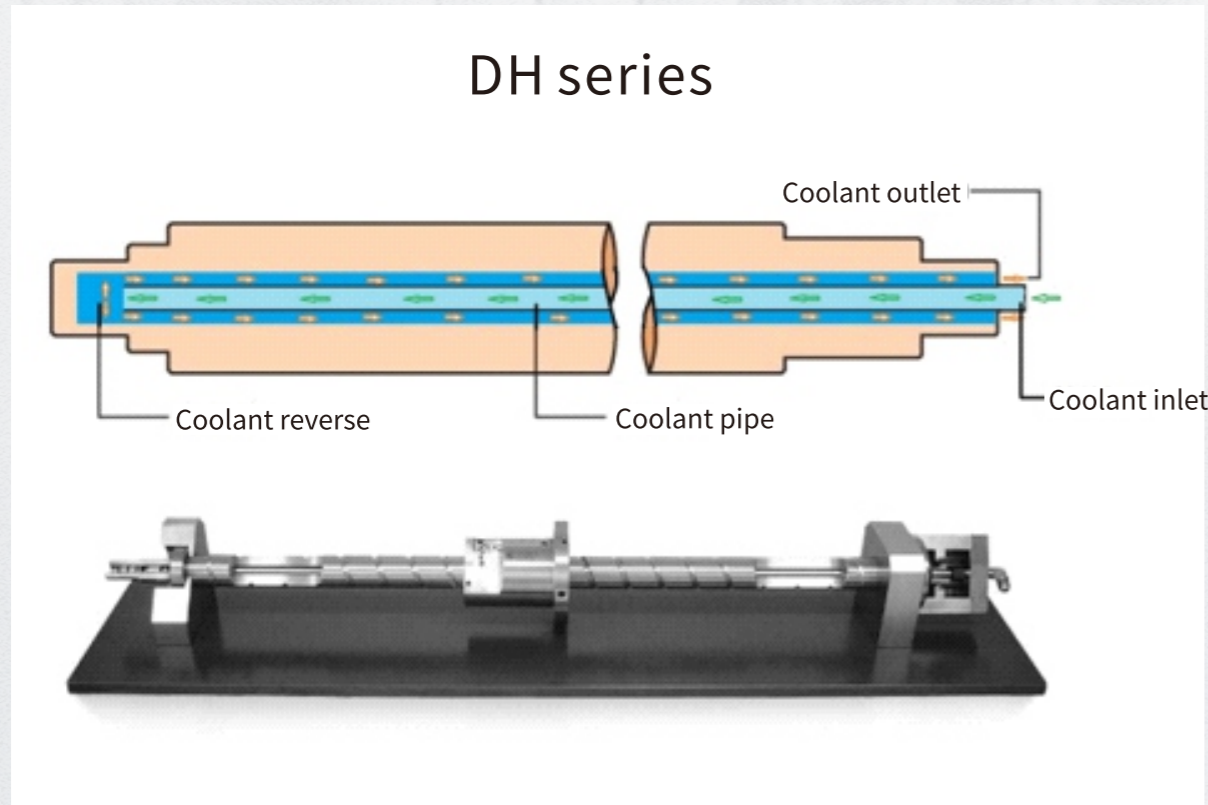

Excellent cutting machining capabilities

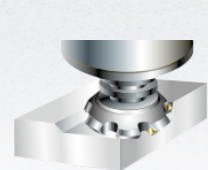

Disc end miller

- ▶ Material: S45C
- ▶ Tool size: F125mm(8chips)
- ▶ Cutting capacity per minute: 700cm³/min
- ▶ Spindle speed: 500r/min
- ▶ Feedrate: 1400mm/min

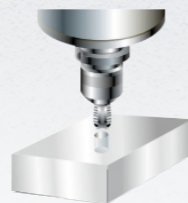

Tapper

- ▶ Material: S45C
- ▶ Tool size: M42XP4.5
- ▶ Spindle speed: 150r/min
- ▶ Feedrate: 675mm/min

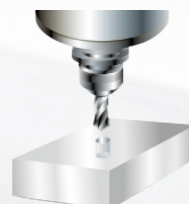

U-shaped driller

- ▶ Material: S45C
- ▶ Tool size: F85mm(8chips)
- ▶ Cutting capacity per minute: 567cm³/min
- ▶ Spindle speed: 600r/min
- ▶ Feedrate: 100mm/min

More higher, more stable working accuracy, faster into thermal stable period, reach to thermal equilibrium in short time

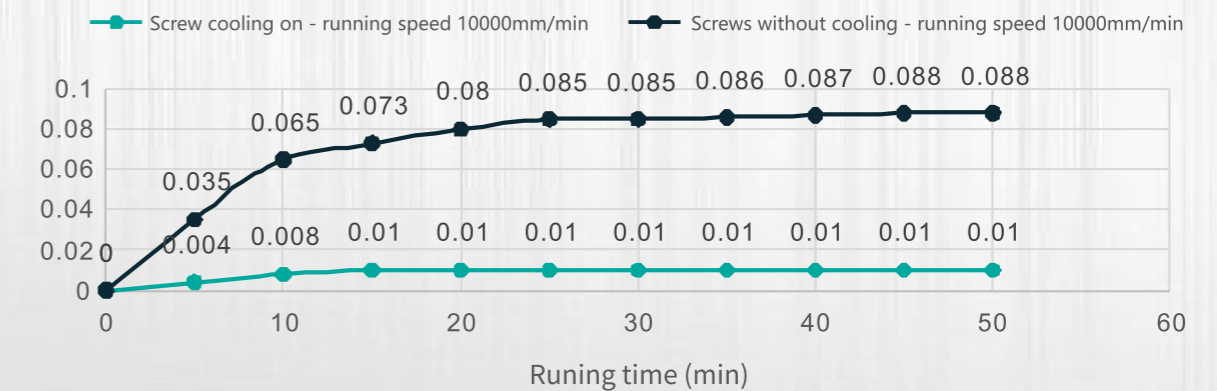
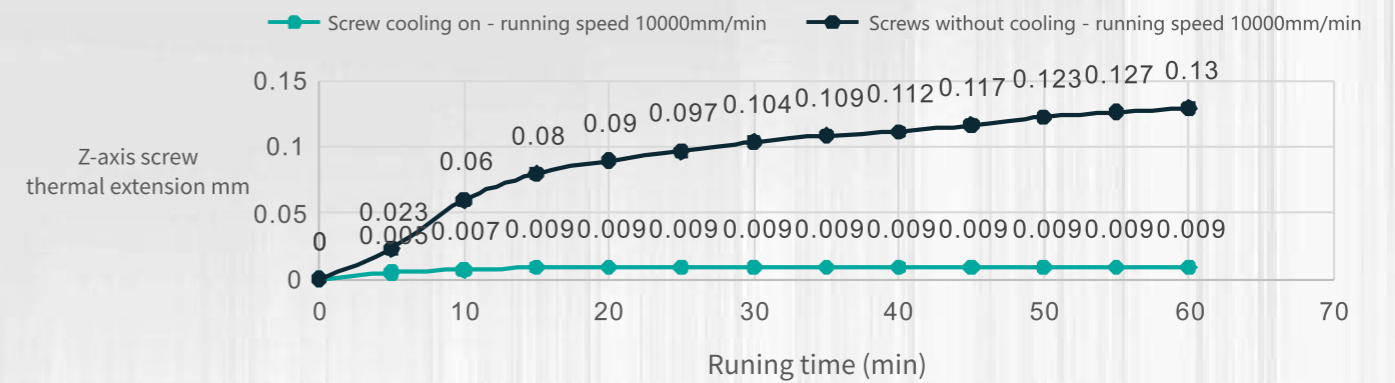
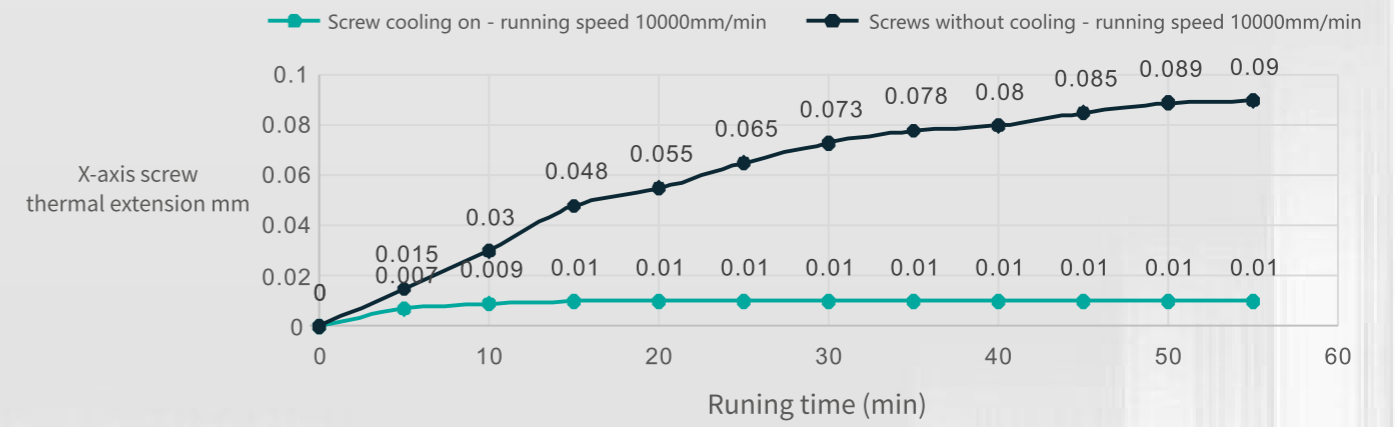

**Reserved more function modules, various optional configurations
 Promoted from standard to high level configuration**

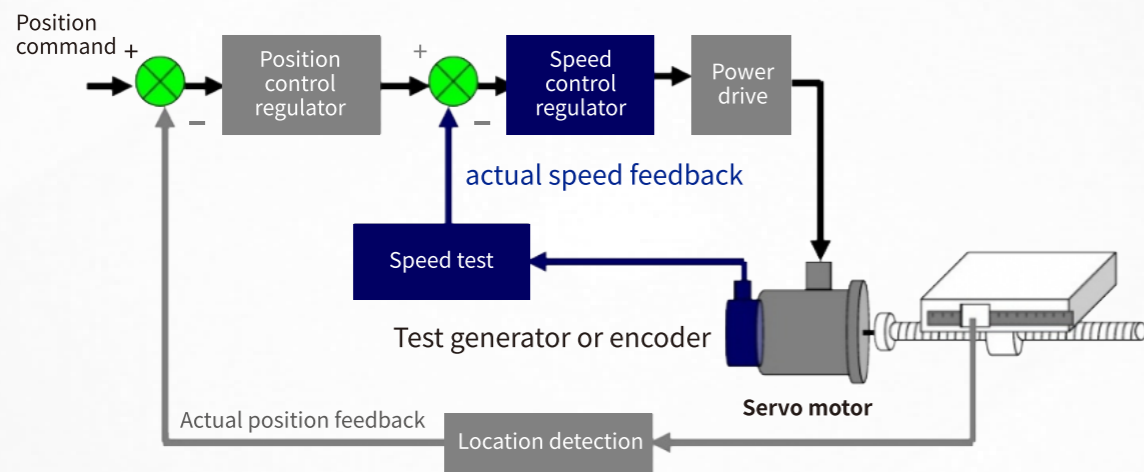

Position feedback system of axes for full closed-loop control of the machine

- Provides optional configuration of grating position feedback.
- X, Y, Z, and B axes are all reserved with fully closed-loop control functions, which can be personalized customization.
- Through the grating ruler installed on each axis, it provides precise position feedback to the control system, realizes full closed-loop control of each axis system, and meets the higher positioning accuracy requirements.

**Internal tool cooling circulation system, precise tool cooling
 smoother drilling and chip removal**

- Providing options of coolant through spindle and tool internal cooling.
- During machine tool processing, it provides precise cooling for the tool, effectively extending the service life of the tool.
- Especially as deep drilling, the internal cooling system not only carries away the heat of the tool, but also carries away the chips inside the hole timely.
- If use the configuration of coolant through spindle, the coolant from the booster pump is filtered
- Variety of coolant pressures are available for the user's processing needs.

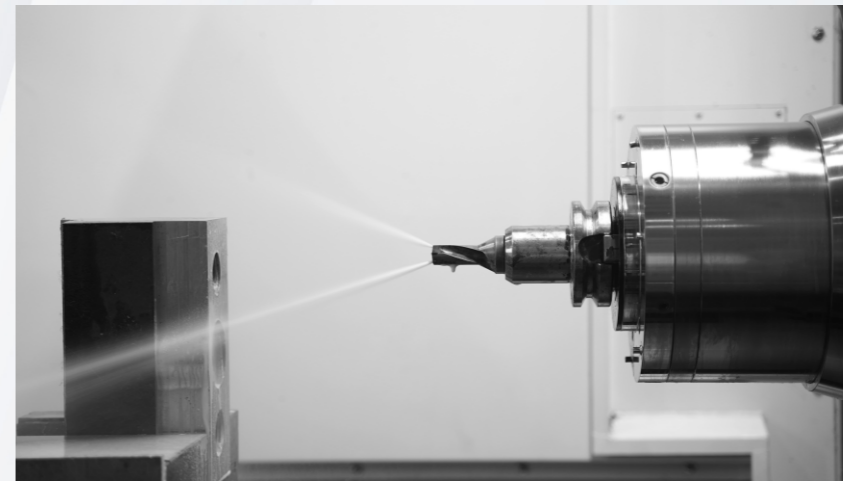

Automatic tool setting and workpiece online measurement

- Contact and non-contact high-precision tool measurement systems can be configured according to customer needs to achieve automatic detection of tool diameter and tool length. It can also perform automated detection of tool damage, tool breakage, etc.
- The workpiece detection probe can be configured according to customer needs, using optical signal transmission to achieve workpiece alignment and online detection.



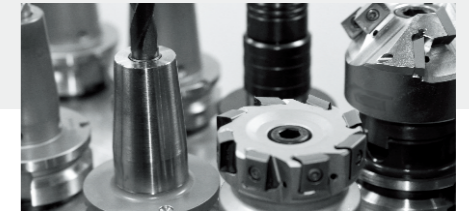

Technical Parameters

DH series

DH-63		
Stroke X/Y/Z	mm	1050/800/1000
Distance from spindle center to worktable surface	mm	120~920
Distance from spindle end to center of worktable	mm	150~1150
Workpiece rotation space	mm	φ1000×1000
Worktable size	mm	630×630
Maximum Worktable Load	kg	1200
Spacing (thread × screw hole)	mm	M16 (125×125)
Minimum setting unit		0.001
Spindle speed	rpm	10000
Spindle taper	#	BT50
Spindle power (rated/short time)	kW	28/42
Spindle torque (rated/short time)	N·m	334/630
Rapid traverse speed	m/min	48
Tool magazine capacity	T	50/60/100
Maximum tool weight	kg	20
Tool length	mm	500
Maximum diameter (full /empty)	mm	105/210
Positioning accuracy (with grating)	mm	0.006
Repeatability (with grating)	mm	0.004
Machine weight (approx.)	kg	21500
System		Siemens

DHS series

DH-100S		
Stroke X/Y/Z	mm	2000/1300/1200
Distance from spindle center to worktable surface	mm	150~1450
Distance from spindle end to center of worktable	mm	350~1550
Workpiece rotation space	mm	φ2000×1800
Worktable size	mm	1000×1250
Maximum Worktable Load	kg	5000
Spacing (thread × screw hole)	mm	9-22×100
Minimum setting unit		0.001
Spindle speed	rpm	10000
Spindle taper	#	BT50
Spindle power (rated/short time)	kW	28/42
Spindle torque (rated/short time)	N·m	334/630
Rapid traverse speed	m/min	24
Tool magazine capacity	T	40
Maximum tool weight	kg	18
Tool length	mm	500
Maximum diameter (full /empty)	mm	125/250
Positioning accuracy (with grating)	mm	0.01
Repeatability (with grating)	mm	0.008
Machine weight (approx.)	kg	19000
System		Siemens

All pictures and parameter configurations in this album are for reference only. The products delivered shall prevail. Our products are being constantly upgraded, and the above information is subject to change without prior notice.

Technical configuration

	DH-63	DH-100S
Roller and liner guide rail	●	●
B-axis grating ruler	●	○
XYZ grating ruler	○	○
Spindle air certain	●	●
Air blowing as spindle unclamping	●	●
Automatic lubrication system	●	●
Spindle cooling system	●	●
Pneumatic system	●	●
Air gun	●	●
Hydraulic station	●	●
Spiral chip conveyor	●	●
Chain chip conveyor	●	●
Full protection	●	●
Three-color warning light	●	●
Air condition of electric cabinet	●	●
Hand wheel	●	●
Door interlock module	●	●
Hollow screw cooling system	●	△
Spray on top of processing area	○	△

● Standard configuration ○ Option ▲ Need consultation △ Not support

	DH-63	DH-100S
Spindle speed 15000rpm (BT40 motorized spindle)	▲	▲
Spindle speed 10000rpm (BT50 motorized spindle)	●	●
Spindle speed 8000rpm (BT50 motorized spindle)○	○	○
Spindle speed 6000rpm (BT50 belt spindle)	△	△
Spindle speed 15000rpm (HSKA63 motorized spindle)	▲	▲
Spindle speed 10000rpm (HSKA100 motorized spindle)	○	○
FANUC systemOi-MF/Plus(2)	○	○
FANUC systemOi-MF/Plus(5)	△	△
Siemens	●	●
Coolant through spindle system3Mpa/7MPa	○	▲
BT40-60T disc-type tool magazine	▲	△
BT50-50T disc-type tool magazine	○	△
BT50-60T disc-type tool magazine	●	△
BT50-40T chain-type tool magazine	▲	●
Automated door	○	○
Oil-mist collector	○	○
Probe	○	○
Tool setter	○	○

● Standard configuration ○ Option ▲ Need consultation △ Not support

Overall machine dimensions/working area

DH-63

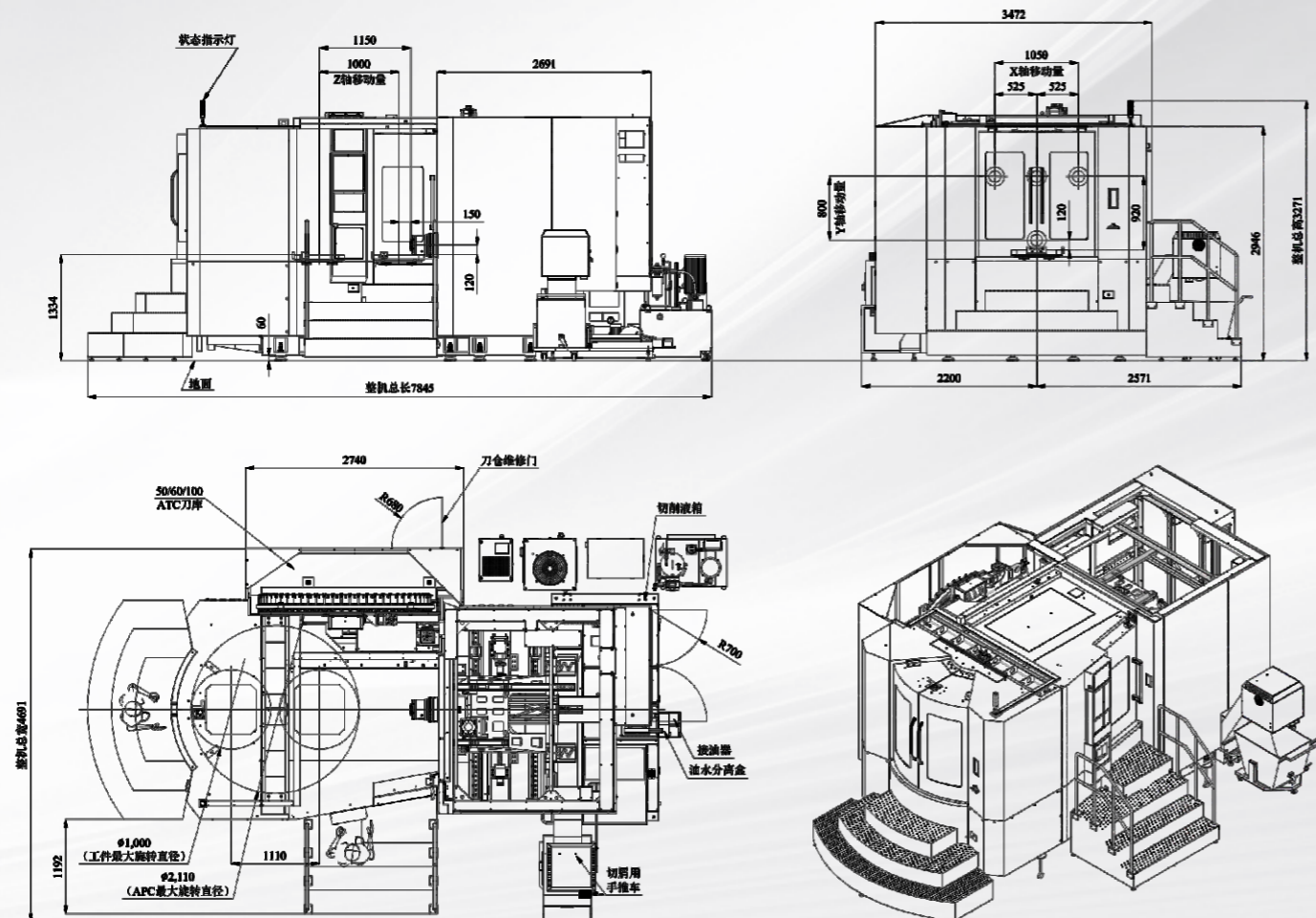

Overall machine dimensions/working area

DH-100S

